

THIS DRAWING AND SPECIFICATIONS ARE THE PROPERTY OF MICROSTRAIN INC. AND SHALL NOT BE REPRODUCED WITHOUT PERMISSION FROM MICROSTRAIN INC.

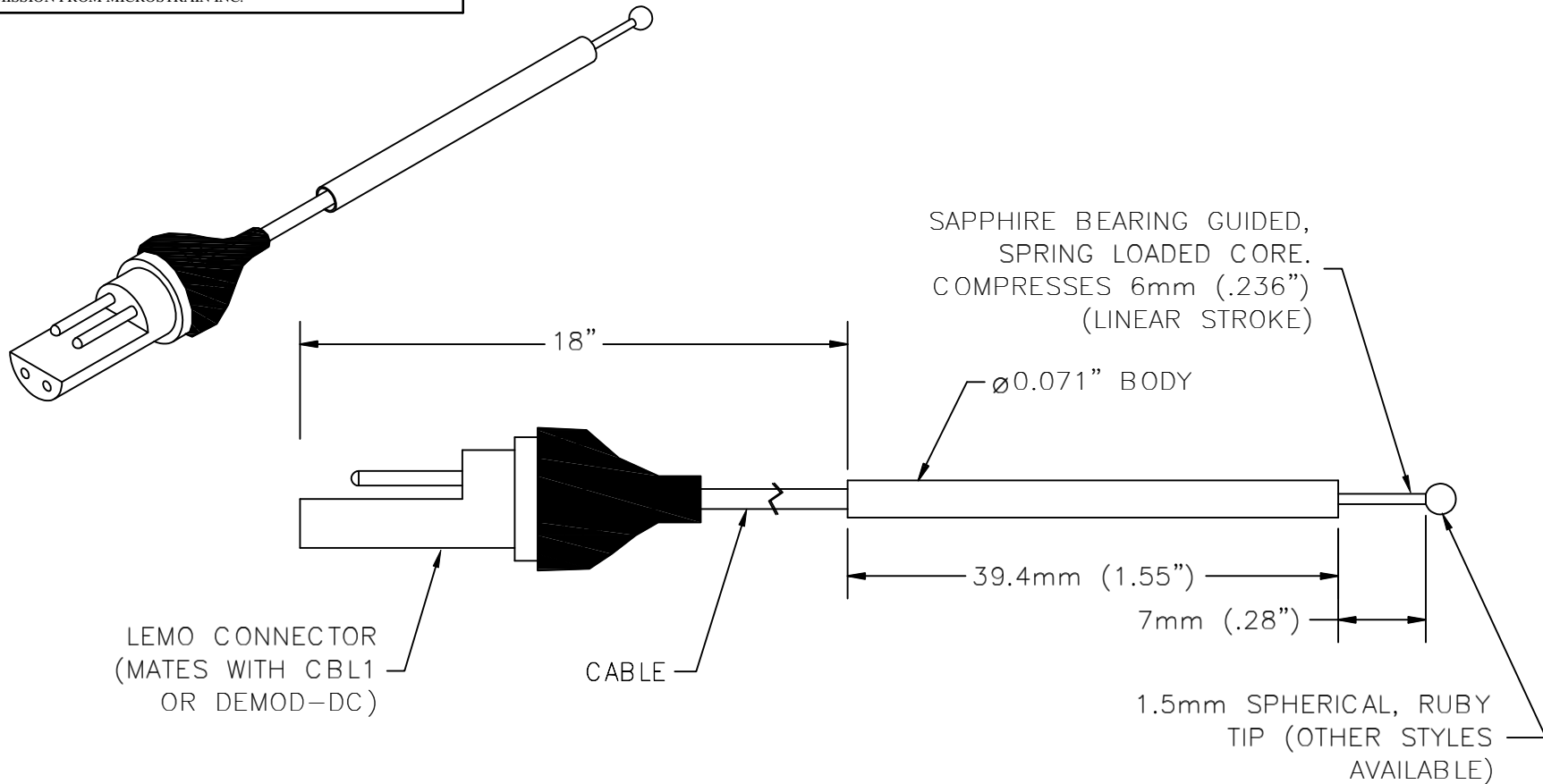

SENSOR CABLE IS SHIELDED AND TEFLON COATED. EACH CONDUCTOR IS WRAPPED AROUND A STAINLESS STEEL WIRE FOR INCREASED TENSILE STRENGTH.

UNLESS OTHERWISE SPECIFIED ALL DIMENSIONS ARE IN INCHES.
 TOLERANCES (UOS)
 FRACTIONS: +/-1/64
 DECIMALS: .XX +/- .01
 .XXX +/- .005
 ANGLES: +/- 0.5 DEGREES
 SURFACE FINISH: 63 MICROINCHES

MicroStrain[®] 310 Hurricane Lane, Suite 4
 Williston, VT 05495
 802-862-6629

TITLE			
MG-DVRT-6			
DRAWN BY: SP/SWM	SIZE A	CAGE CODE 0XYZ9	DWG NO. 6103-0100
APPROVED BY:	SCALE 3:1	DATE: 16 MAY 2002	REV 0
		SHEET 1 OF 1	